



MAVERICK



IN-DEALERSHIP TRAINING



Preproduction vehicles and computer-generated images shown throughout.

THE FIRST-EVER STANDARD FULL HYBRID PICKUP IN AMERICA



MAVERICK

AN UNTAPPED MARKET	3
EXCEPTIONAL VALUE	6
EXTERIOR STYLE + FEATURES	8
INTERIOR FEATURES + FUNCTIONALITY	14
KEEPING UP WITH TECHNOLOGY	21
INTRODUCING FLEXBED™	23
PERFORMANCE + HANDLING	31
BUILT FORD TOUGH CAPABILITY + DURABILITY	36
RESERVATIONS + ORDERING	39
FOR MORE INFORMATION	40

THIS TRAINING SESSION WILL HELP YOU:

- Understand what makes Maverick unique in the marketplace and the remarkable value it represents across all three models (XL, XLT and Lariat)
- Demonstrate the surprising versatility and do-it-yourself customization possibilities of the Maverick FLEXBED™
- Present how Maverick delivers an impressive balance of practicality and capability
- Effectively explain driver-assist and connectivity technologies to first-time new-vehicle buyers who may be unfamiliar with these features
- Identify how Maverick fits in the Ford Truck lineup and delivers Built Ford Tough capability, ruggedness and durability



The 2022 Maverick creates a new affordable compact pickup segment where an empty, white space had existed:

- First and only standard full-hybrid pickup in America and the most fuel-efficient pickup on the market with a targeted EPA-estimated rating of 37 combined mpg¹
- No other hybrid in America has a lower starting MSRP of \$19,995 USD²
- Unexpectedly upscale, feature-rich and roomy cabin as flexible as compact SUVs but with FLEXBED™ versatility

"JUST-RIGHT" SIZE

Not too big, not too small – makes it an attractive alternative to larger pickups, compact SUVs and traditional sedans

¹2.5L Hybrid powertrain. Actual mileage will vary. Final EPA estimated ratings available later in the 2021 calendar year.

²MSRP for base vehicle. Excludes destination/delivery fee plus government fees and taxes, any finance charges, any dealer processing charge, any electronic filing charge, and any emission testing charge. Optional equipment not included. Starting A, Z and X Plan price is for qualified, eligible customers and excludes document fee, destination/delivery charge, taxes, title and registration. Not all vehicles qualify for A, Z or X Plan.

Compared to larger pickups, Maverick is easier to maneuver, able to take advantage of smaller parking spots and fits garages that are shorter and have lower overhead clearance.

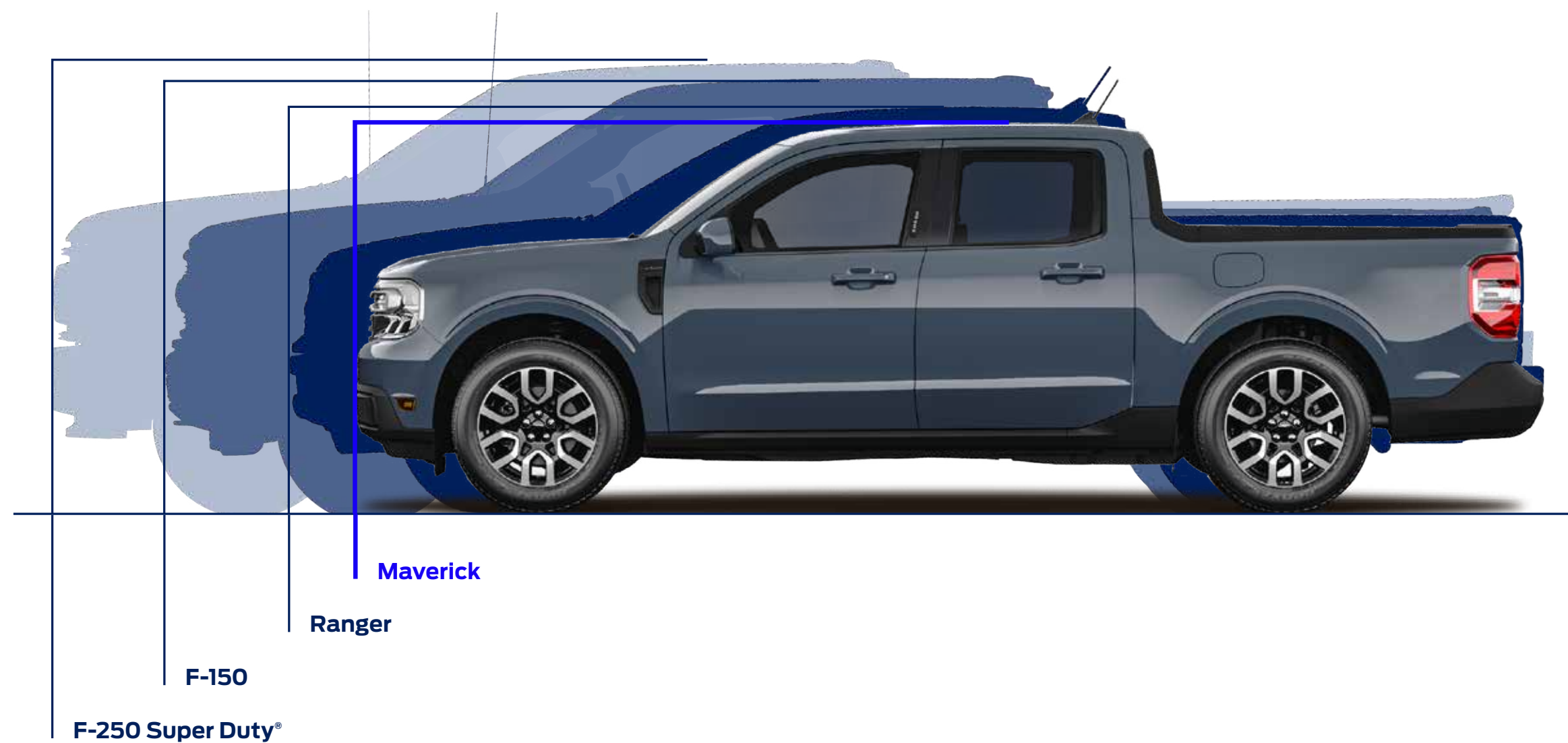

2022 Maverick SuperCrew® FWD

Length	199.7"
Width ¹	72.6"
Height	68.7"
Turning Diameter ²	40.0'
FLEXBED™ Length	4-1/2'

2021 F-150 SuperCrew® 4x2

Length	231.7"
Width ¹	79.9"
Height	75.6"
Turning Diameter ²	47.8'
Box Length	5-1/2'

2021 Ranger SuperCrew® 4x2

Length	210.8"
Width ¹	73.3"
Height	71.1"
Turning Diameter ²	42.0'
Box Length	5'

2021 F-250 Crew Cab 4x2

Length	250.0"
Width ¹	80.0"
Height	79.3"
Turning Diameter ²	54.7'
Box Length	6-3/4'

ABOUT THE SIZE OF IT

With an unexpectedly roomy interior, the compact Maverick compares favorably against Midsize Pickups. In fact, Maverick provides 3" more rear legroom than Toyota Tacoma!

¹Vehicle width without mirrors
²Curb-to-curb turning diameter

MEET THE NEW MAVERICK CUSTOMERS

Maverick delivers attributes that will attract a new range of customers to Ford, some who never knew they needed a truck and may not think of themselves as “truck people.”

- Approach life with a can-do spirit and an efficient, on-the-go lifestyle – maneuverability and hybrid powertrain will be appealing
- Generally younger and more diverse than the average pickup owner – appreciate a versatile vehicle that allows them to work and play on their own terms
- Unafraid to take on a do-it-yourself project or use their vehicle as a “maker space” – they will recognize the advantages of the FLEXBED™ pickup box and Built Ford Tough capability
- Many will be first-time new-vehicle buyers looking for a great value – they may be unfamiliar with the latest features and technologies found on Maverick
- Like to stay connected with their friends and family– they will see great value in Maverick connectivity features

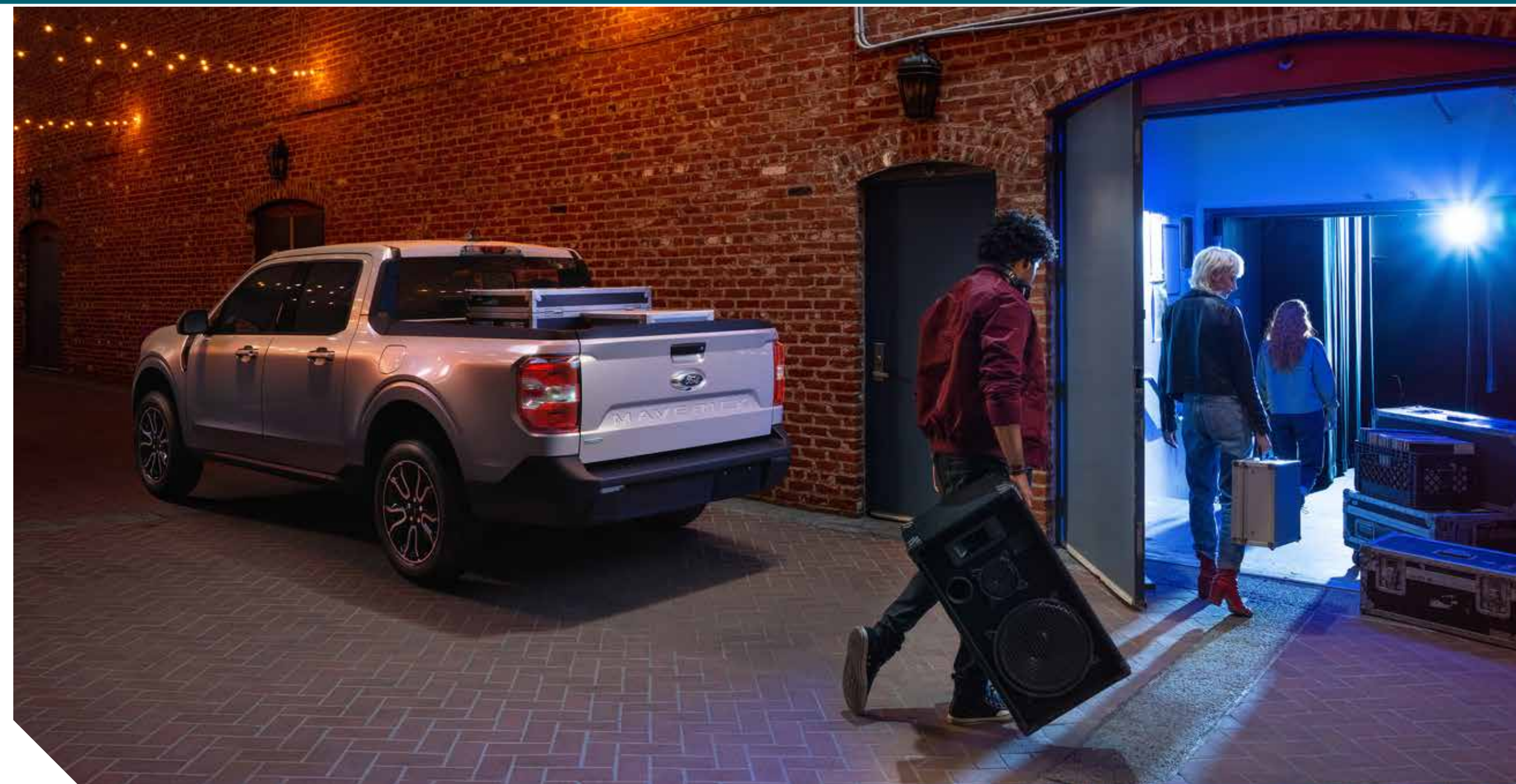



XL

STARTING AT \$19,995¹

Well-equipped and affordable – the first standard full hybrid pickup!



XLT

STARTING AT \$22,280¹

Ride in style to the next level of versatility with added features and available upgrades.



Lariat

STARTING AT \$25,490¹

Lead the way in comfort, capability and technology...plus an available First Edition Package.

¹MSRP for base vehicle. Excludes destination/delivery fee plus government fees and taxes, any finance charges, any dealer processing charge, any electronic filing charge, and any emission testing charge. Optional equipment not included. Starting A, Z and X Plan price is for qualified, eligible customers and excludes document fee, destination/delivery charge, taxes, title and registration. Not all vehicles qualify for A, Z or X Plan.

SUPERCREW[®] WITH 4.5-FOOT FLEXBED[™]

Maverick is offered only in a SuperCrew cab configuration with room for five adults and creative in-cab storage solutions. The innovative FLEXBED pickup box design delivers surprising versatility while maintaining its maneuverable, garageable compact size.

STANDARD ON EVERY MAVERICK

- 2.5L Hybrid engine with electric continuously variable transmission (eCVT)
- 2,000-lb. max trailer tow capacity and 1,500-lb. max payload¹
- Autolamp (Auto On/Off Headlamps) and Auto High-Beam Headlamps
- Pre-Collision Assist with Automatic Emergency Braking (AEB) and Post-Collision Braking
- Rear View Camera with Dynamic Hitch Assist
- 8" Bluetooth[®] touchscreen with Android Auto[™] and Apple CarPlay[®] compatibility
- FordPass Connect[™] with 4G LTE Wi-Fi hotspot capability²
- Smart-charging USB ports in instrument panel (one type A and one type C) and 12V power outlets (front and rear)
- Seven airbags including driver's knee airbag, front-seat airbags and Safety Canopy[®] System with side-curtain airbags and rollover sensor
- AdvanceTrac[™] with RSC[®] (Roll Stability Control[™])
- Individual Tire Pressure Monitoring System (TPMS; excludes spare)

¹Towing and payload are independent attributes and may not be achieved simultaneously. Max towing varies based on cargo, vehicle configuration, accessories and number of passengers. Max payload varies and is based on accessories and vehicle configuration. See label on door jamb for carrying capacity of a specific vehicle. ²FordPass, compatible with select smartphone platforms, is available via a download. Message and data rates may apply. FordPass Connect, and complimentary Connected Service are required for remote features (see FordPass Terms for details). Connected service and features depend on compatible AT&T network availability. Evolving technology/cellular networks/vehicle capability may limit functionality and prevent operation of connected features. Connected service excludes Wi-Fi hotspot. Wi-Fi hotspot includes wireless data trial that begins upon AT&T activation and expires at the end of 3 months or when 3GB of data is used, whichever comes first. To activate, go to www.att.com/ford. The Bluetooth word mark is a trademark of the Bluetooth SIG, Inc. Apple CarPlay is a trademark of Apple Inc., registered in the U.S. and other countries. Android Auto is a trademark of Google LLC.

AVAILABLE ON EVERY MAVERICK

- 2.0L EcoBoost[®] engine with Auto Start-Stop Technology and 8-speed automatic transmission
- All-wheel drive (AWD; requires 2.0L EcoBoost engine)
- Trailer hitch receiver with 4-pin connector
- 4K Tow Package (requires 2.0L EcoBoost engine and AWD; see page 36 for details)
- 120V/400W AC power outlet on rear of center console
- Ford Co-Pilot360[™] Package (see page 22 for details)
- Power tilt/slide moon roof

GENUINE FORD ACCESSORIES

A full range of accessories are available including bedliners, bed extender, tonneau covers, bed divider kit, bed cross bars, bed lighting and more.

XL

The bold styling of a Built Ford Tough® truck

Power dome hood

Cargo lamp integrated with CHMSL

Single-bar, black mesh grille with black surround

LED headlamps

17" Steel wheels

Model-specific fender badge

Smooth, sculpted body panels

FLEXBED™

Rail and tailgate moldings

Six tie-downs

Manual locking multi-position tailgate

2x4/2x6 Pockets

12V/15A Pre-wires



XLT

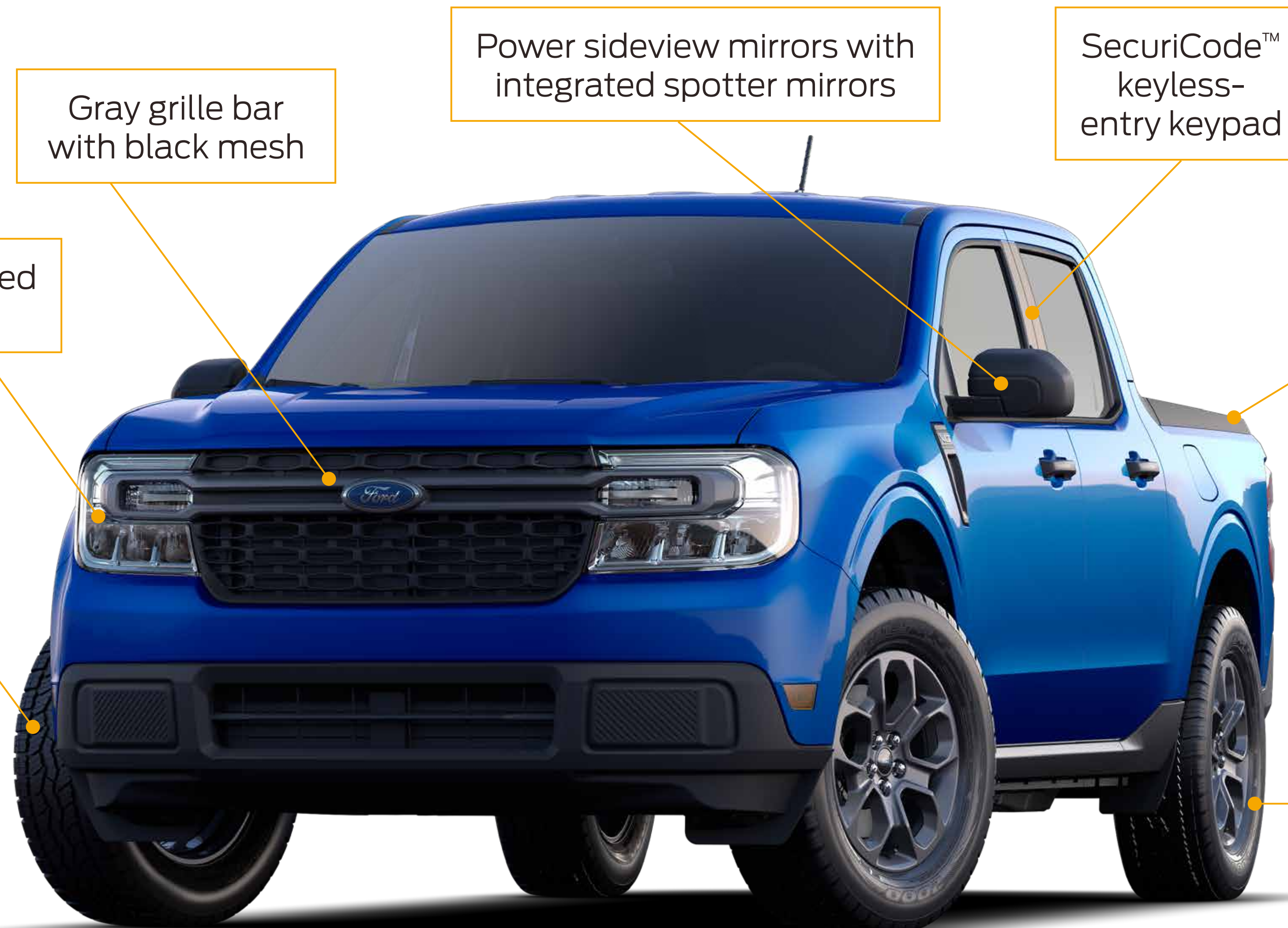

Gray grille bar with black mesh

Power sideview mirrors with integrated spotter mirrors

SecuriCode™ keyless-entry keypad

Wiper-activated headlamps

17" Painted aluminum wheels

17" unique aluminum wheel with A/T tires (included in FX4 Pkg)

17" alloy wheel with aggressive A/T tire (optional; requires 4K Tow Package or FX4 Off-Road Package)

FLEXBED™

Cubby storage (passenger side)

Four additional tie-downs for a total of 10

Power tailgate lock

Perimeter anti-theft alarm

Lariat



Body-color mirror caps, door handles and tailgate handle

Silver grille bar with black mesh

LED signature accent lighting (incandescent taillamps)

FLEXBED™

Cubby storage on both sides

18" Bright aluminum wheels

18" Black painted aluminum wheel (optional)

17" unique aluminum wheel with A/T tires (included in FX4 Pkg)

17" alloy wheel with aggressive A/T tire (optional; requires 4K Tow Package or FX4 Off-Road Package)

Intelligent Access with Push-Button Start

Lariat

First Edition Package

*Requires Lariat Luxury Package;
not available with FX4 Package
or 2.0L EcoBoost with FWD*

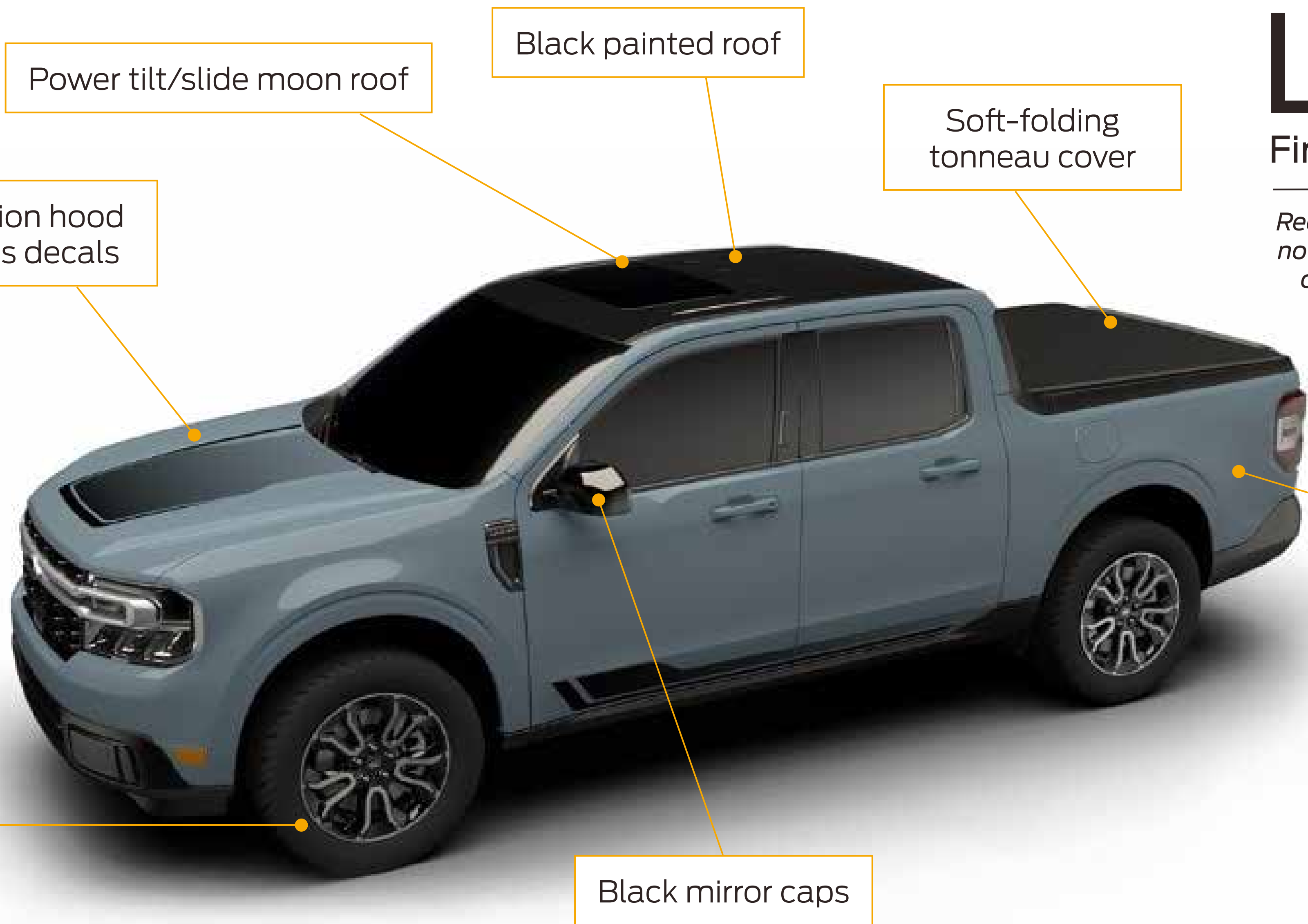

Power tilt/slide moon roof

Black painted roof

Soft-folding tonneau cover

Unique First Edition hood and side graphics decals

18" black painted wheels (hybrid)

17" unique aluminum wheel with A/T tires (gas)

Black mirror caps

THREE COLORS

Area 51

Carbonized Gray

Rapid Red (exclusive to First Edition; extra cost)

AVAILABLE WHEELS



17" STEEL WHEELS
(STANDARD ON XL)



17" PAINTED ALUMINUM WHEELS
(STANDARD ON XLT)



17" UNIQUE ALUMINUM WHEELS WITH A/T TIRES
(INCLUDED IN FX4 PACKAGE AND FIRST EDITION PACKAGE 2.0L ECOBOOST®)



17" ALLOY WHEELS WITH A/T TIRES
(OPTIONAL ON XLT AND LARIAT; REQUIRES 4K TOW PACKAGE OR FX4 OFF-ROAD PACKAGE)



18" BRIGHT ALUMINUM WHEELS
(STANDARD ON LARIAT)



18" BLACK-PAINTED ALUMINUM WHEEL
(OPTIONAL ON LARIAT AND INCLUDED IN FIRST EDITION PACKAGE 2.5L HYBRID)

AVAILABLE PAINT COLORS



SHADOW
BLACK



OXFORD
WHITE



AREA 51



CACTUS
GRAY



CARBONIZED
GRAY METALLIC



ICONIC SILVER
METALLIC



VELOCITY BLUE
METALLIC



ALTO BLUE
TINTED
CLEARCOAT
METALLIC*
(XLT and Lariat only)



CYBER ORANGE
TRI-COAT
METALLIC*
(XLT and Lariat only)



HOT PEPPER
RED TINTED
CLEARCOAT
METALLIC*
(XLT and Lariat only)



RAPID RED
METALLIC
TRI-COAT*
(late availability;
First Edition Package only)

*Extra cost

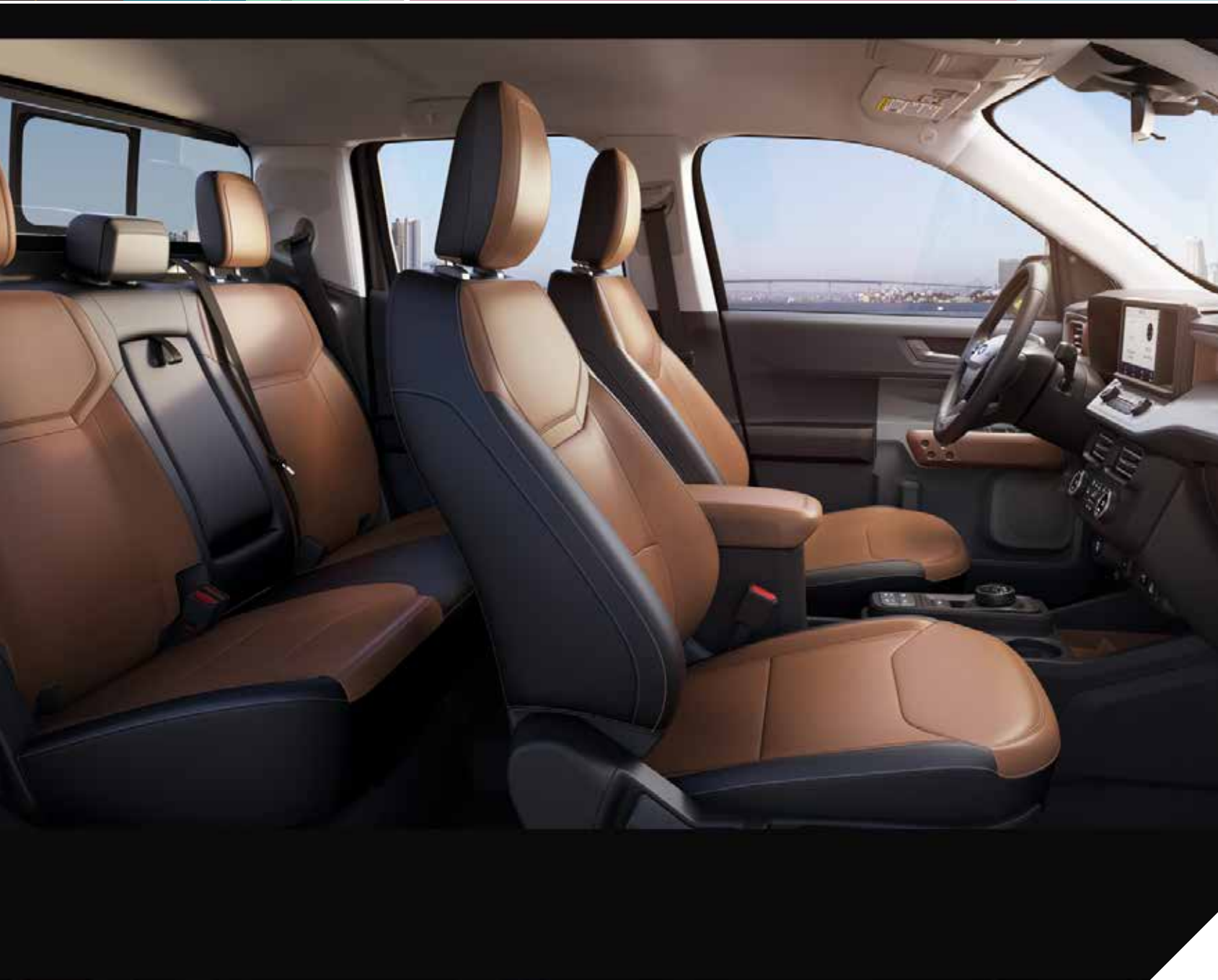

Flexible and Roomy Interior

Maverick is a truck that feels like an SUV with excellent maneuverability and seating for five. There is ample leg room for all, and the transformative unibody design helps to minimize the center hump, while creative storage solutions help to maximize interior flexibility.

Door-Pocket Storage

The unique design of the door panels and hand levers can accommodate a 1.5L water bottle or tablet.

Standard Rear-Seat Storage

Provides a good place to stow sports equipment, tools, gear and other things you want to keep organized and out of the way.



Center Console Storage

The large center console and numerous storage bins help keep items organized. The standard rotary shifter frees up space and a wireless charging pad¹ is included in the optional Lariat Luxury Package.

¹Available Qi wireless charging may not be compatible with all phones.

Instrument Panel Storage

A convenient storage bin is located behind the center stack screen, perfect for sunglasses. There is an additional bin in the space next to the screen.



FITS (Ford Integrated Tether System)

Slots on the back of the center console and inside the rear-seat storage bins make it easy to attach and swap out various available accessories. These include a cup holder, storage/trash bin, cord organizer, grocery hook and dividers for the under-seat storage.

Backseat Biker

Maverick can accommodate a bicycle with the front tire removed, helping to keep it secure and protected from the elements while you are away from the vehicle.



Do not drive with an unsecured bike in rear seat.

XL



- Black Onyx/Medium Slate interior with cloth-trimmed seats
- 4.2" LCD cluster screen
- Steering wheel audio controls
- Tilt/telescoping steering wheel
- Autolamp Automatic On/Off Headlamps
- 8" Bluetooth® touchscreen with Apple CarPlay® and Android Auto™ compatibility¹
- Ice Blue ambient light (center console)
- AM/FM stereo with six speakers
- Smart-charging USB ports
- Front and rear 12V powerpoints

¹Requires phone with active data service and compatible software. SYNC 3 does not control 3rd party products while in use. 3rd Parties are solely responsible for their respective functionality. The Bluetooth word mark is a trademark of the Bluetooth SIG, Inc. Apple CarPlay is a trademark of Apple Inc., registered in the U.S. and other countries. Android Auto is a trademark of Google LLC.

XLT



- Navy Pier/Medium Slate interior with unique cloth-trimmed seats
- Orange accents
- Cruise control
- Rear seat armrest and cupholders



- 8-way power driver and 6-way manual passenger front seats
- Leather-wrapped, heated steering wheel
- Heated sideview mirrors with body-color caps
- Heated front seats
- Heated wiper park
- Remote Start System (key fob)
- Trailer hitch receiver with 4-pin wiring harness
- Full-size spare (hybrid only)

FLEXBED™ enhancements:

- 120V/400W AC power outlet (also adds AC outlet and USB ports on rear of center console)
- LED lighting
- Tie-down rails with two locking brackets (replace two side tie-downs for a total of 10)
- Spray-in bedliner

¹MSRP for package only. Excludes destination/delivery fee plus government fees and taxes, any finance charges, any dealer processing charge, any electronic filing charge, and any emission testing charge. Optional equipment not included. Starting A, Z and X Plan price is for qualified, eligible customers and excludes document fee, destination/delivery charge, taxes, title and registration. Not all vehicles qualify for A, Z or X Plan.

XLT
 Luxury Package
 \$2,345 MSRP¹

Lariat

- Desert Brown interior with ActiveX™ seating
- 8-way power driver and 6-way manual passenger front seats
- Leather-wrapped steering wheel
- Intelligent Access with Push-Button Start
- 6.5" LCD cluster screen
- Sound-deadening windshield
- Ice Blue ambient lighting (center console, front footwells and door handle pockets)
- Dual-zone Electronic Automatic Temperature Control
- Two rear USB ports
- Power sliding rear window
- Driver seatback map pockets
- One touch up/down front and rear windows
- Dual illuminated visor mirrors
- Available Lariat Luxury Package (see next page)



- SYNC® 3 – Enhanced Voice Recognition Communications System¹
 - B&O Premium Audio System with 8 speakers
 - SiriusXM with 3-month All Access trial subscription²
 - Wireless charging pad³
 - Adaptive Cruise Control with Stop-and-Go and Lane Centering
 - Evasive steering assist
 - Reverse Sensing System
 - Heated sideview mirrors
 - Heated front seats
 - Heated steering wheel
 - Heated wiper park
 - Remote Start System (key fob)
 - 4-Way headrests (front)
 - Trailer hitch receiver with 4-pin wiring harness
 - Full-size spare tire
- FLEXBED™ enhancements:**
- 120V/400W AC power outlet (also adds AC outlet on rear of center console)
 - LED lighting
 - Tie-down rails with two locking brackets (replace two side tie-downs for a total of 10)
 - Spray-in bedliner

¹Don't drive while distracted or while using handheld devices. Use voice-operated systems when possible. Some features may be locked out while the vehicle is in gear. Not all features are compatible with all phones. ²Available Feature. SiriusXM audio and data services each require a subscription sold separately, or as a package, by Sirius XM Radio Inc. If you decide to continue service after your trial, the subscription plan you choose will automatically renew thereafter and you will be charged according to your chosen payment method at then-current rates. Fees and taxes apply. To cancel you must call SiriusXM at 1-866-635-2349. See SiriusXM Customer Agreement for complete terms at www.siriusxm.com. All fees and programming subject to change. ³Available Qi wireless charging may not be compatible with all phones. ⁴MSRP for package only. Excludes destination/delivery fee plus government fees and taxes, any finance charges, any dealer processing charge, any electronic filing charge, and any emission testing charge. Optional equipment not included. Starting A, Z and X Plan price is for qualified, eligible customers and excludes document fee, destination/delivery charge, taxes, title and registration. Not all vehicles qualify for A, Z or X Plan.

Sirius, XM and all related marks and logos are trademarks of Sirius XM Radio Inc. BANG & OLUFSEN© 2021 and B&O© 2021. BANG & OLUFSEN™ and B&O™ are registered trademarks of Bang & Olufsen Group. Licensed by Harman Becker Automotive Systems Manufacturing Kft. All rights reserved.

Lariat

Luxury Package

\$3,340 MSRP; requires Ford Co-Pilot360™ Package (\$540 MSRP)⁴





Standard on Maverick XL, XLT and Lariat

- 8" Bluetooth® touchscreen (NOTE: This has a similar look as SYNC® 3, but does not have embedded voice commands)¹
- Hands-free calling capability with pass-through of phone voice commands
- Android Auto™ and Apple CarPlay® compatibility (USB connection required)²
- 911 Assist® and AppLink®
- FordPass™ Connect with 4G LTE Wi-Fi hotspot and FordPass connectivity³

Included in the Optional Lariat Luxury Package

- SYNC 3 Voice Recognition Communications System¹
- Hands-free calling capability with SYNC 3 voice commands
- Android Auto™ and Apple CarPlay® compatibility (USB connection required)
- 911 Assist® and AppLink®
- FordPass™ Connect with 4G LTE Wi-Fi hotspot and FordPass connectivity³

¹Don't drive while distracted or while using handheld devices. Use voice-operated systems when possible. Some features may be locked out while the vehicle is in gear. Not all features are compatible with all phones.

²Requires phone with active data service and compatible software. SYNC 3 does not control third-party products while in use. Third parties are solely responsible for their respective functionality.

³FordPass Connect, the FordPass App and complimentary Connected Service are required for remote features (see FordPass Terms for details). Connected service and features depend on compatible AT&T network availability. Evolving technology/cellular networks/vehicle capability may limit functionality and prevent operation of connected features. Connected service excludes Wi-Fi hotspot.

The Bluetooth word mark is a trademark of the Bluetooth SIG, Inc. Apple CarPlay is a trademark of Apple Inc., registered in the U.S. and other countries. Android Auto is a trademark of Google LLC.

STANDARD ON EVERY MAVERICK

- Pre-Collision Assist with Automatic Emergency Braking (AEB), Pedestrian Detection and Forward Collision Warning with Dynamic Brake Support
- Post-Collision Braking
- Autolamp (Automatic On/Off Headlamps) and Auto High-Beam Headlamps
- Rear View Camera with Dynamic Hitch Assist
- Trailer Sway Control
- Hill start assist
- Auto Hold
- Grade Assist (2.5L Hybrid engine only)
- Individual Tire Pressure Monitoring System (TPMS)

OPTIONAL FORD CO-PILOT360™ PACKAGE (AVAILABLE ON XL, XLT AND LARIAT):

- BLIS (Blind Spot Information System) with Cross-Traffic Alert
- Lane-Keeping System, including Lane-Keeping Aid, Lane-Keeping Alert and Driver Alert
- Full-size spare tire (hybrid only)

OPTIONAL LARIAT LUXURY PACKAGE ADDS:

- Adaptive Cruise Control with Stop-and-Go and Lane Centering
- Reverse Sensing System
- Evasive Steering Assist

Driver-assist features are supplemental and do not replace the driver's attention, judgment and need to control the vehicle. It does not replace safe driving. See Owner's Manual for details and limitations.



DESIGNED TO ADAPT

The Maverick 4.5-foot FLEXBED can fit your gardening supplies, camping gear, band equipment or even an ATV. Plus, the design makes it easy to add a bike rack, various types of dividers and more with a little creativity and a simple trip to the hardware store.

- A** Comfortable 30" lift-in height with the tailgate down
- B** Low sides for easy access to items on floor
- C** Six tie-downs on XL (two on each side and two on the tailgate)
- D** Additional four tie-downs on XLT and Lariat (one added on each side and two at the front of the floor)
- E** Multi-position locking tailgate extends bed length to 6' in the lower position
- F** Power locking tailgate standard on XLT and Lariat; available theft-prevention hinge lock from Ford Accessories
- G** Cargo width above the wheelhouses of more than 53" can accommodate 4' wide panels
- H** 2x4 and 2x6 pockets allow for a variety of DIY loading configurations with numerous bulkhead and divider locations

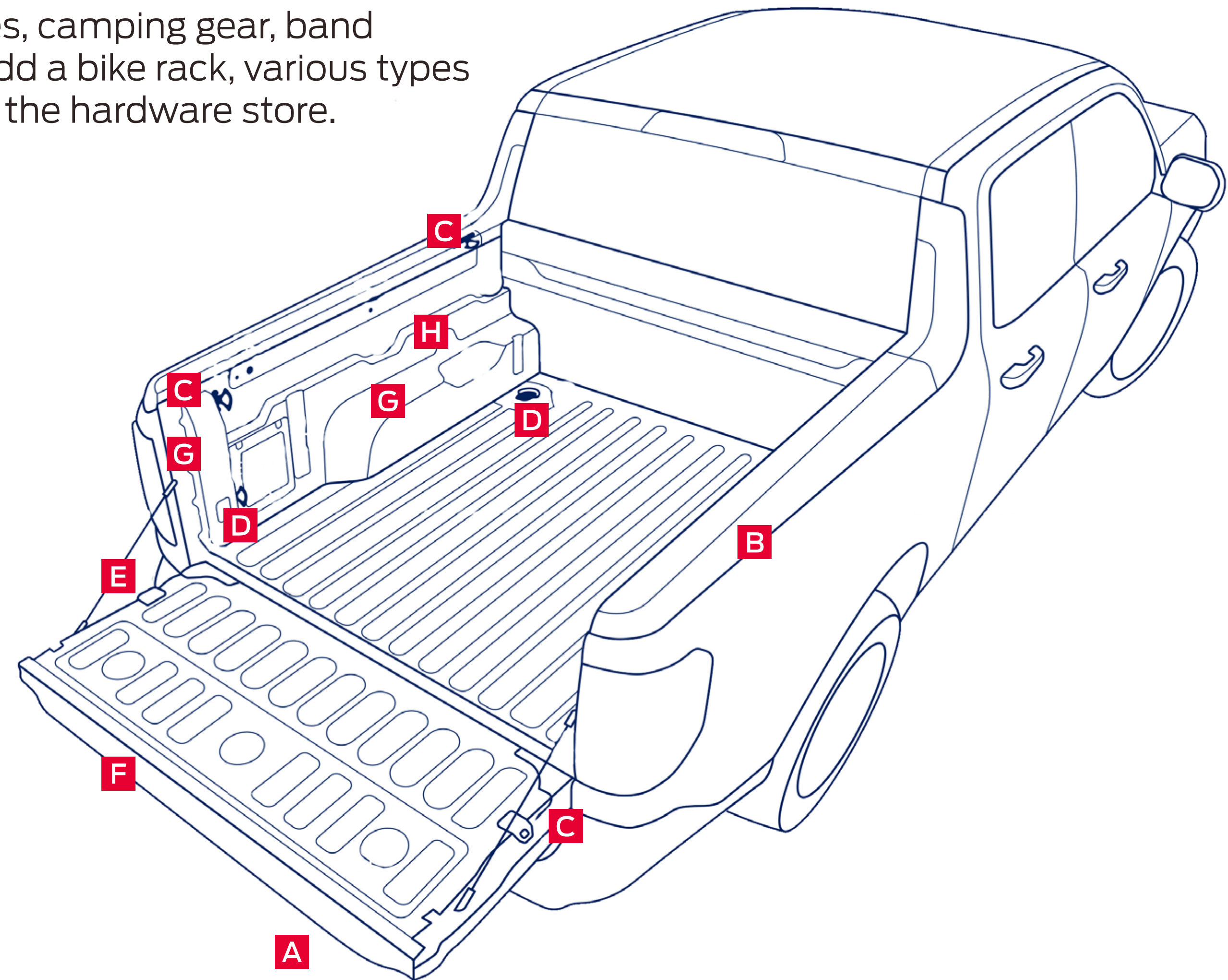

MULTI-POSITION TAILGATE

Place the tailgate cables in the upper position to accommodate longer items such as building materials or bikes. It can support up to 400 lb. in this position.

- Top of the angled tailgate lines up with the wheelhouses
- Flat carry 4' x 8' sheets of plywood and drywall – no need to angle the materials
- Supports up to 18 sheets of $\frac{3}{4}$ " plywood when properly secured

The tie-downs located on the sides of the tailgate double as bottle openers.

DIY INNOVATIONS – LET YOUR IMAGINATION RUN WILD!

With a few basic tools and off-the-shelf supplies from the lumber yard, hardware store or big box home improvement warehouse, customers can equip Maverick with an amazing range of Do-It-Yourself (DIY) upfits, often at much less cost than factory or aftermarket accessories.

Accommodate: Bike rack mounting options available from Ford Accessories.

Enable: Create your own DIY bike rack for about \$45 in materials from the hardware store.

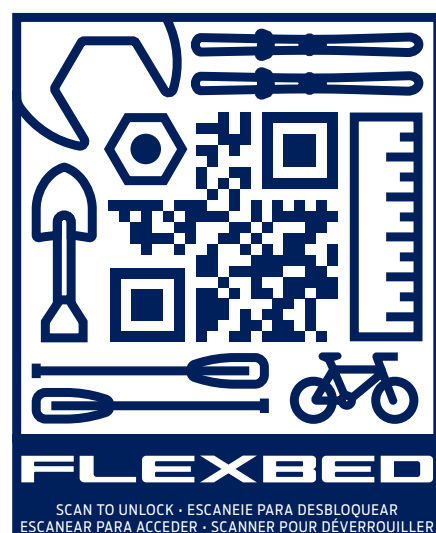

Data rate may apply.

Scan the FLEXBED QR code for a quick link to the Discover Your Ford site that includes DIY examples and “how-to” videos. These are located on the cubby covers/ closeout panels as well as in the rear-seat storage area and Quick Reference Guide.

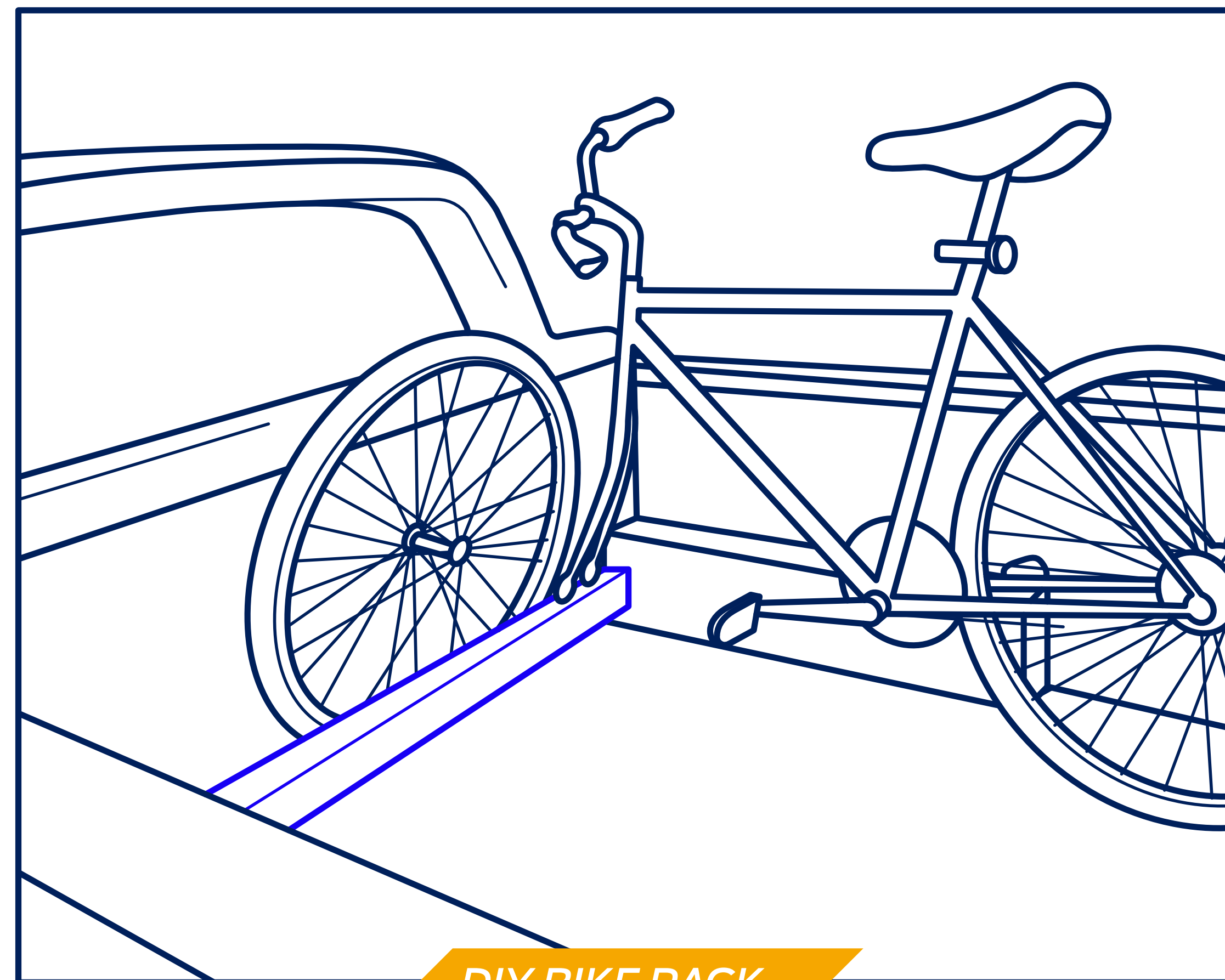

DIY BIKE RACK

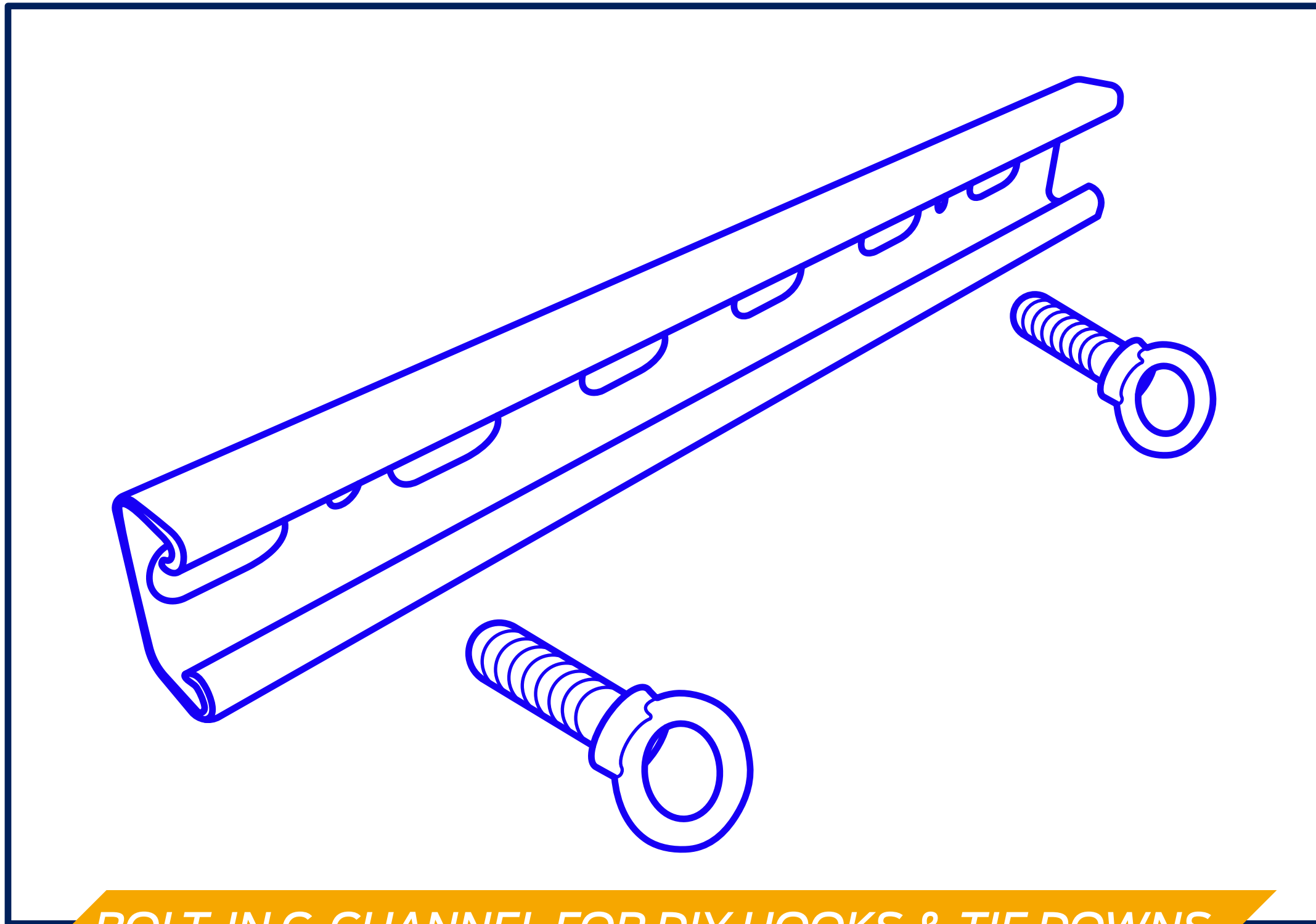

BOLT-IN C-CHANNEL FOR DIY HOOKS & TIE DOWNS

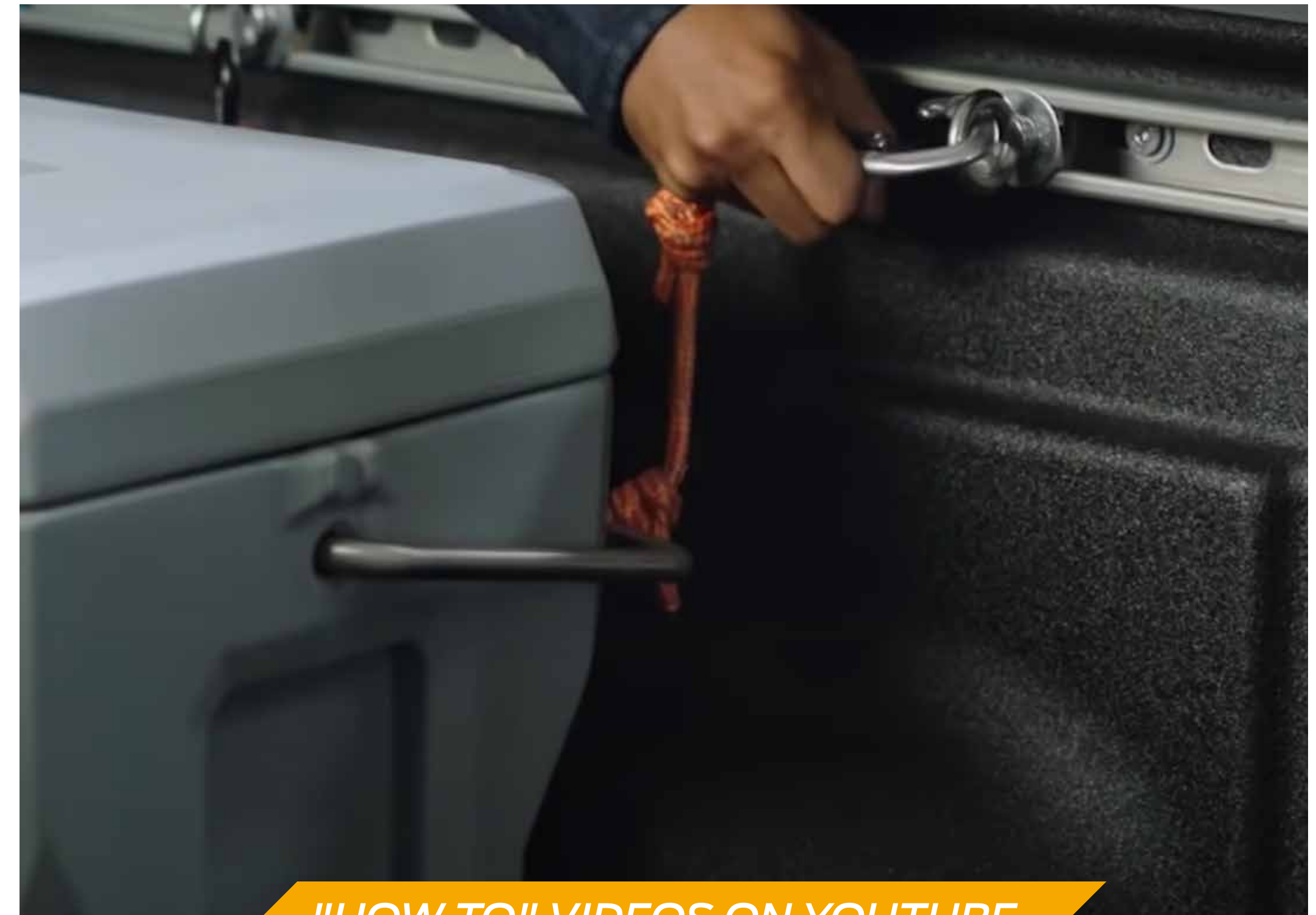

"HOW TO" VIDEOS ON YOUTUBE

Accommodate: Tie-down rails with two brackets included in XLT and Lariat Luxury Packages.

Enable: Threaded holes in the FLEXBED sides allow for DIY C-channels and hooks to create your own tie-down system.



Accommodate: Bed divider and bed crossbars available from Ford Accessories

Enable: Create your own DIY dividers and bulkheads using common lumber.

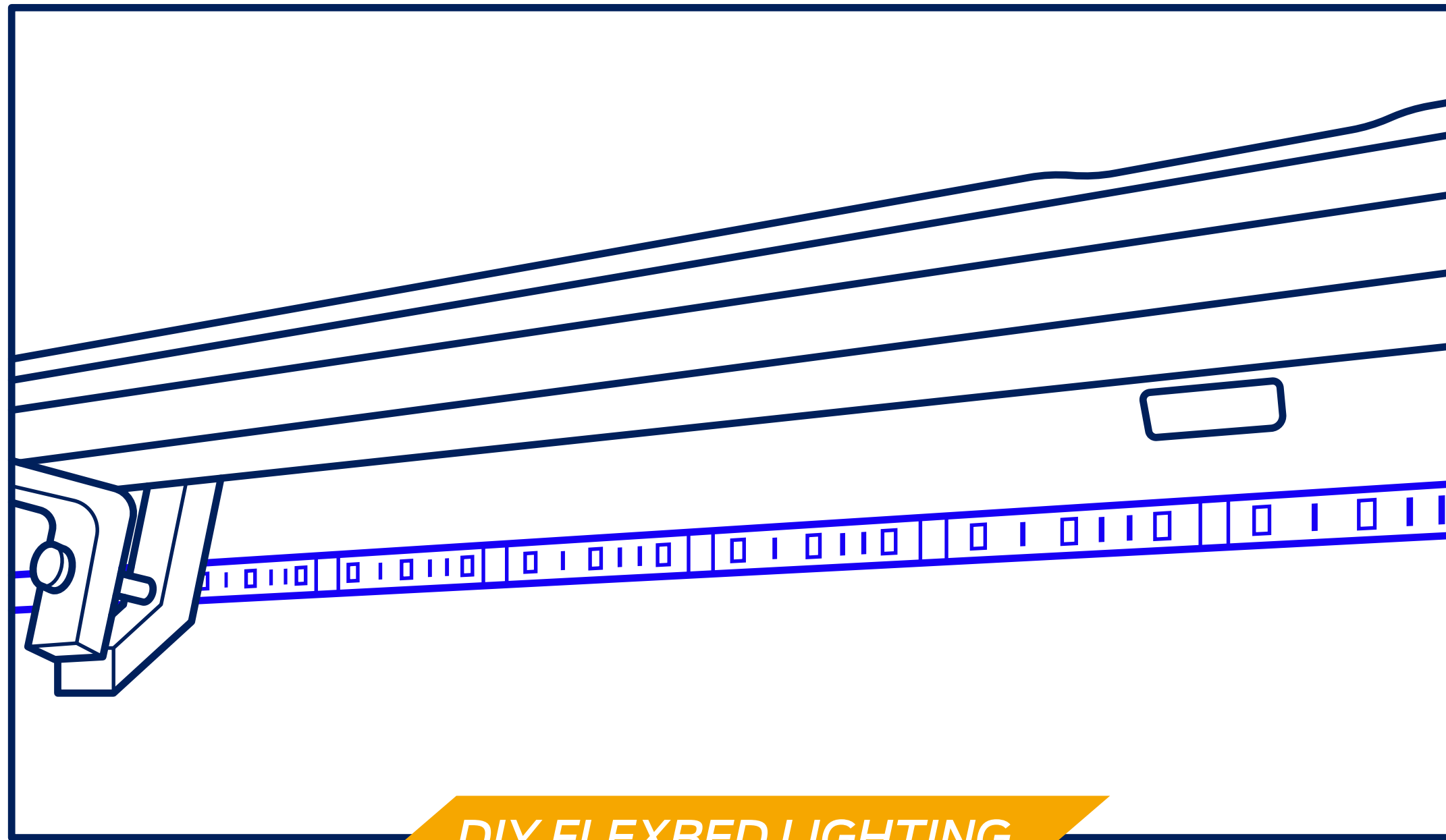
**DIY FLEXBED LIGHTING**

Accommodate: LED lighting included in the XLT and Lariat Luxury Packages; available light system from Ford Accessories.

Enable: Create your lighting system using the two 12V/20A pre-wired power sources located at each side of the tailgate opening.

**CONSIDER THE POSSIBILITIES!**

Not just for lighting, you can use the pre-wired 12V connectors to power an air compressor, small TV, mini-fridge and more.

- Two pre-wired 12V connections located inside each D-pillar
- Up to 15A (180W) total power output
- One plug-in adapter provided



- XLT features a single covered cubby on the passenger side of the FLEXBED™
- Lariat has a covered cubby on both sidewalls

Available 120V/400W AC power outlet is included in the XLT and Lariat Luxury Packages (replaces the driver-side cubby on Lariat). FLEXBED LED lighting is also included in these packages.

A closeout panel covers the opening where the cubby would be located on XL (both sides) and XLT (driver's side without the Luxury Package). These can be opened to gain access to the space between the fender and box side to create your own DIY storage or power outlet solutions.



TRENDING ACCESSORIES

- Three Available Tonneau Covers for enhanced security and protection from the elements: (1) durable soft folding cover, (2) hard tri-fold cover or (3) hard rollup cover
- Available Bed Extender provides up to 6' of bed length with the tailgate down
- Available Bed Cap is designed to complement Maverick styling and smoothly integrates with the SuperCrew® cab – eliminates the “will-it-fit” guesswork and compromised styling of aftermarket bed caps

GENUINE FORD ACCESSORIES

A complete range of genuine Ford Accessories makes it easy for Maverick customers to personalize styling, add capability, enhance versatility and more. Check out the Build & Price feature at ford.com or visit accessories.ford.com to see all that's available.



STANDARD 2.5L HYBRID ENGINE – THE FIRST-EVER STANDARD FULL HYBRID PICKUP!

- Gas engine alone produces 162 hp and 155 lb.-ft. of torque¹
- Electric traction motor delivers 94 kW/173 lb.-ft. at peak battery power for on-demand hybrid torque responsiveness
- Generates 191 hp with the gas engine and electric motor working together
- Electric Continuously Variable Transmission (eCVT)
- Liquid-cooled lithium-ion battery pack
- Front-wheel drive (FWD) only

Maverick fits your budget and your values

- No other hybrid in America has a lower starting MSRP of \$19,995 USD²
- No other truck is more fuel efficient than the 2022 Maverick full-hybrid with its targeted EPA-estimated 37 combined MPG³
- Maverick with the 2.5L Hybrid engine has a targeted EPA-estimated range of 500 miles on a single tank of gas³

¹Horsepower and torque are independent attributes and may not be achieved simultaneously. Horsepower and torque ratings based on premium fuel per SAE J1349® standard. Your results may vary.

²MSRP for base vehicle. Excludes destination/delivery fee plus government fees and taxes, any finance charges, any dealer processing charge, any electronic filing charge, and any emission testing charge. Optional equipment not included. Starting A, Z and X Plan price is for qualified, eligible customers and excludes document fee, destination/delivery charge, taxes, title and registration. Not all vehicles qualify for A, Z or X Plan.

³2.5L Hybrid powertrain. Actual mileage will vary. Final EPA estimated ratings available later in the 2021 calendar year. Range calculation based on 13.8-gallon tank and a targeted EPA-estimated 37 combined mpg. Actual range will vary.



OPTIONAL 2.0L ECOBOOST® ENGINE

- Front-wheel drive (FWD) or optional all-wheel drive (AWD) available on all models
- 250 hp and 277 lb.-ft. torque¹
- Turbocharged and direct injection
- 8-Speed automatic transmission
- Auto Start-Stop technology

¹Horsepower and torque are independent attributes and may not be achieved simultaneously. Horsepower and torque ratings based on premium fuel per SAE J1349® standard. Your results may vary.

SELECTABLE DRIVE MODES

Designed to enhance control, handling and performance in different driving conditions. The standard drive modes are included with both engines. Unique drive modes are included with the FX4 Off-Road Package (requires 2.0L EcoBoost and AWD).

	NORMAL	ECO	SPORT	SLIPPERY	TOW/HAUL	MUD/RUTS	SAND
STANDARD MODES	✓	✓	✓	✓	✓		
FX4 OFF-ROAD PACKAGE	✓			✓	✓	✓	✓

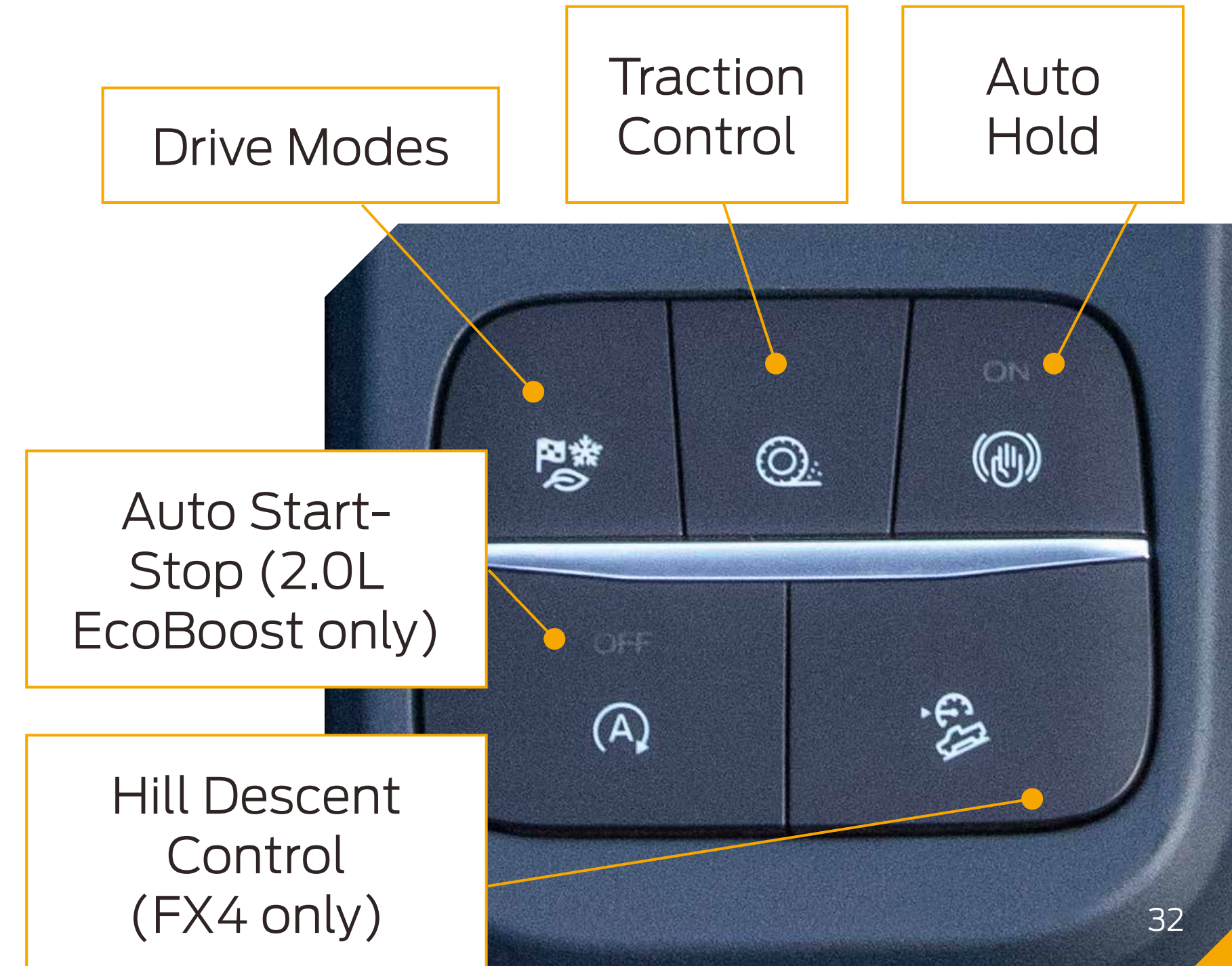

Unibody vehicles can be tuned for a smooth, quiet ride and enhanced handling characteristics compared to body-on-frame trucks. In addition, the reduced weight of unibody construction contributes to fuel economy.



THE STRONG, SILENT TYPE

With its sturdy, solid unibody design, Maverick strikes the ideal balance between ride quality and sporty fun-to-drive handling, along with Built Ford Tough capabilities and ruggedness – exactly what compact pickup customers want.

- **Independent MacPherson strut-type front suspension** with coil springs, twin-tube hydraulic gas-pressurized shocks, stabilizer bar, aluminum lower control arms, steel sub-frame and cast aluminum knuckles
- Front-Wheel Drive (FWD) models have a **twist-beam rear suspension with integrated stabilizer bar**, Ford-patented force vector springs and twin-tube, hydraulic gas-pressurized shocks – optimized for ride, handling and load-carrying capability with FWD
- All-Wheel Drive (AWD) models (2.0L EcoBoost® only) have an **independent multi-link trailing arm rear suspension** with twin-tube hydraulic gas-pressurized shocks, coil springs, stabilizer bar, steel sub-frame and cast aluminum knuckles – optimized for AWD performance without sacrificing load-carrying capability
- **EPAS (Electric Power-Assisted Steering)** is speed-sensitive to provide light, responsive steering when parking and less assist at higher speeds for more confident control

FX4 OFF-ROAD PACKAGE

Take the road less traveled and escape back to nature with your friends. The Maverick FX4 Off-Road Package is an available option on XLT and Lariat with the 2.0L EcoBoost® engine and AWD. It clearly links Maverick to the rest of the Built Ford Tough truck lineup, with:

- Exposed front tow hooks
- 6.5" LCD Cluster screen with off-road display
- Two FX4-only drive modes (Mud/Ruts and Sand replace Eco and Sport)
- 17" Unique aluminum wheels
- All-terrain tires or optional off-road all-terrain tires
- Enhanced suspension and shocks
- Hill Descent Control
- Protective skid plates
- Trailer hitch receiver with 4-pin connector
- Increased capacity radiator with upgraded cooling fan
- "FX4 Off-Road" decals





AUTO HOLD (ALL MODELS)

- Turn on/off by pushing the Auto Hold button next to the rotary shifter
- Keeps the vehicle at a complete stop until the driver presses the accelerator – especially useful in stop-and-go traffic and at traffic lights
- Rear brake lights remain illuminated when Auto Hold is engaged



HILL START ASSIST (ALL MODELS)

- Always active with no selectable settings
- Helps keep the vehicle from rolling back when on a slope as the driver's foot is transitioning from brake pedal to accelerator
- Aids in situations such as pulling away on a parking structure ramp, accelerating from traffic lights on an incline or when reversing uphill

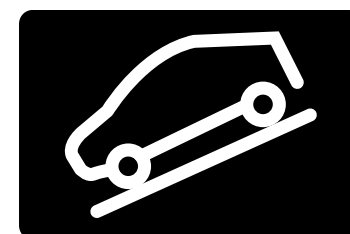

GRADE ASSIST (2.5L HYBRID ENGINE ONLY)

- Activated through the Driver Assistance Settings in the instrument cluster
- Uses regen braking to automatically maintain vehicle speed when coasting down a grade
- Can also use engine compression braking when regen is limited

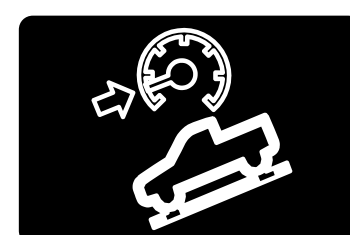

HILL DESCENT CONTROL (FX4 OFF-ROAD PACKAGE ONLY)

- Turn on/off by pushing the Hill Descent Control button next to the rotary shifter
- Essentially a cruise control system that allows the driver to set and maintain a vehicle speed between 2 mph and 20 mph while descending steep grades on various surface conditions
- Uses the Anti-Lock Brake System (ABS) to help the driver control the vehicle's descent, allowing the driver to concentrate on steering

MAVERICK

2,000-LB. MAX
TOW STANDARD¹



COMPACT SIZE, MIGHTY CAPABILITIES

Both Maverick powertrains deliver a standard trailer tow rating up to 2,000 lb., enough for a pair of jet skis, snowmobiles or a good-sized pop-up camper.

- Rear View Camera with Dynamic Hitch Assist, Trailer Sway Control and Hill Start Assist are all standard
- Available trailer hitch with 4-pin electrical connector

Available 4K Tow Package

Double that standard rating for a max capacity up to 4,000 lb. This gives you the capability to trailer things like a 21' speed boat, a pair of riding mowers or a 23' camper. Requires 2.0L EcoBoost[®] with AWD and includes:

- Trailer hitch receiver with both 4-pin and 7-pin connectors
- Integrated Trailer Brake Controller
- Transmission oil cooler
- Upgraded radiator and cooling fan
- Upgraded final drive ratio from 3.63:1 to 3.81:1

4,000-LB. MAX
TOW AVAILABLE¹



¹Max towing varies based on cargo, vehicle configuration, accessories and number of passengers

MAVERICK



PLENTY OF PAYLOAD

Load up your bulk groceries, landscaping supplies, camping gear and sports equipment or simply make that big move in just one trip. And consider this... Maverick has 100 lb. more max payload than the midsize Chevrolet Colorado 2.5L 4-cylinder at 1,400 lb.!

¹Max payload varies and is based on accessories and vehicle configuration. See label on door jamb for carrying capacity of a specific vehicle. Properly secure all cargo.



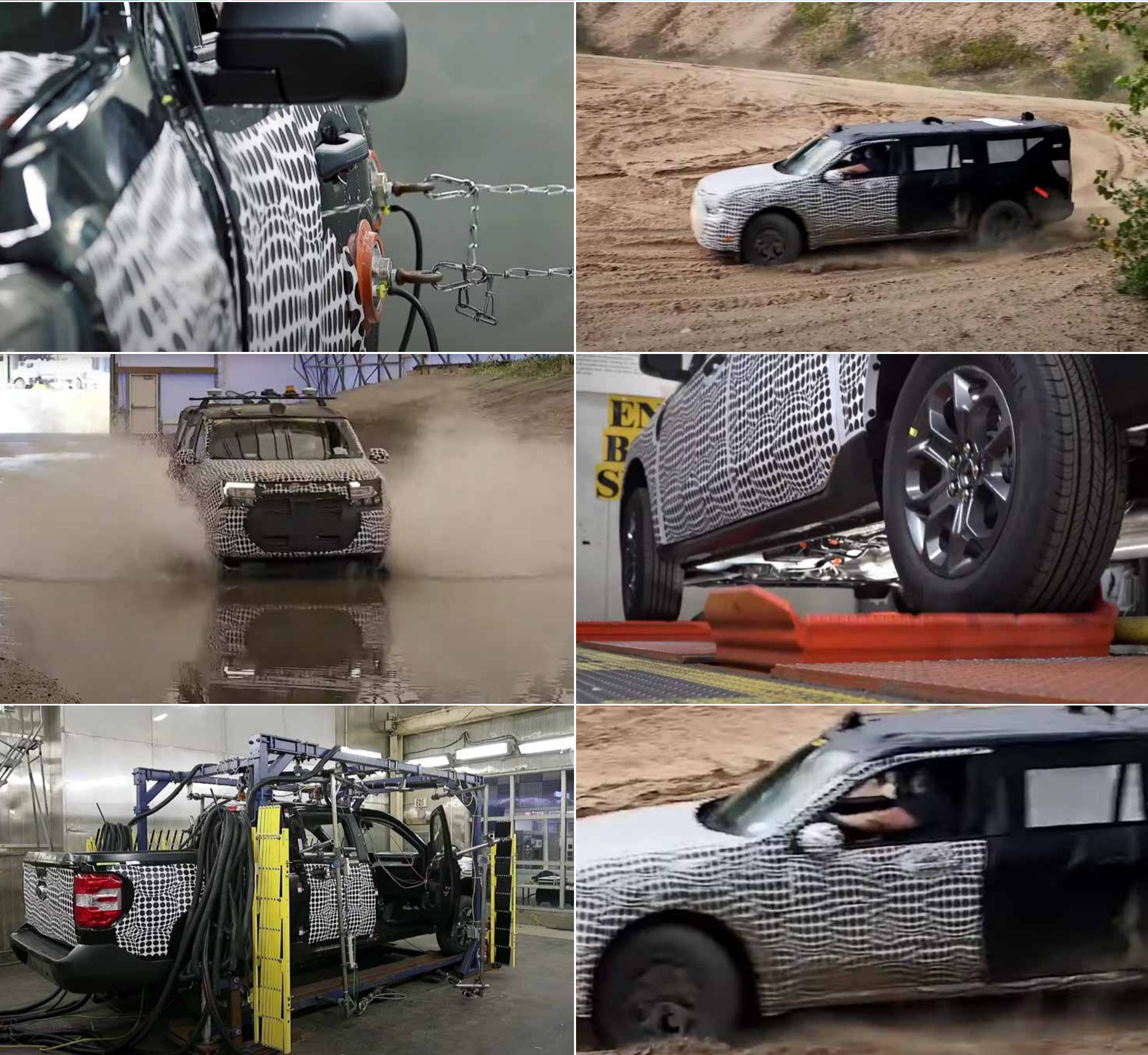

TORTURE TESTING

Maverick underwent the same type of grueling, no-holds-barred testing every Ford Truck must endure before it can earn the right to be called Built Ford Tough. 19 Million miles of real world and simulated testing was conducted!

- Towing trailers and hauling payload well beyond rated capacities
- Barrel drop tests to verify the strength of the FLEXBED™
- Extensive cross-country towing and load hauling in arctic cold and desert heat
- Extreme engine load and thermal shock tests that push the limits of both the 2.5L Hybrid and 2.0L EcoBoost® powertrains
- Salt baths and acidified sprays to test for corrosion
- And much more

- No deposit required and customers can choose from three different reservation paths:
 - Simple nameplate level reservation (no model selection required)
 - Early build-and-price configuration reservation
 - Direct-to-dealer website reservation
- Customer provides email contact via Ford.com Maverick page
- Reservations delivered as “hot leads” to customer-selected Dealer

Your critical role in the process...

- Consult with customer as soon as possible to confirm vehicle configuration and equipment
- Convert reservation into retail order via the Retail Order Verification Program (ROVP) to schedule vehicle for production
- Customer receives updates on order status during production
- Deliveries are scheduled to begin this Fall — finalize the purchase and conduct delivery at vehicle arrival

Maverick Reservation Job Aid (Ford.com)



Introducing Maverick on Ford.com

Customers can kick off the buying process for the all-new 2022 Ford Maverick online, with the launch of a Reservation experience, coinciding with Order banks opening.

Customers can choose their preferred Dealer, select the Maverick nameplate, view the starting price, and complete a Reservation form to submit their Reservation.

Dealers will work with the Customer to confirm their vehicle configuration and place their Order. Additional Customer communications have been created to keep Customers apprised of their vehicle's build status. When the vehicle is ready, Dealers will continue to guide Customers through the remainder of the purchase process in-store.

Please Note: This Reservation experience **will not** have a full online order experience. To learn more, please visit the [Maverick Vehicle Details Page](#)

KEY HIGHLIGHTS:

- Dealerization by preferred name search or ZIP code
- Reservations at nameplate level only (no trim series)
- No Reservation Deposit
- Simple Reservation and Build & Price Reservation experiences send a lead form to the Dealer CRM
- An experience is available on Dealer websites and can be added by contacting platform providers

DEALER SETUP: No Dealer setup is required.

LEAD SOURCE:

- Vehicle Details Page: [FD OEM Reservation](#)

HOW IT WORKS

- SETUP**
 - No Dealer action needed for Tier 1
- RESERVE**
 - Customer places Reservation with their preferred Dealer with the [nameplate page](#) or [Build & Price on Ford.com](#)
 - Dealer receives Reservation in their CRM (*see lead source on the left*)
 - Dealer engages the Customer to discuss the Order process
- ORDER**
 - Customer works with Dealer to confirm their configuration and place their Order
 - Dealer manually enters Order into WBDO and confirms Customer information
 - Customer receives updates on their Order being scheduled and produced through the Global Order To Delivery (GOTD) communications
- BUY**
 - Upon vehicle arrival, Dealer engages the Customer directly to complete the purchase process

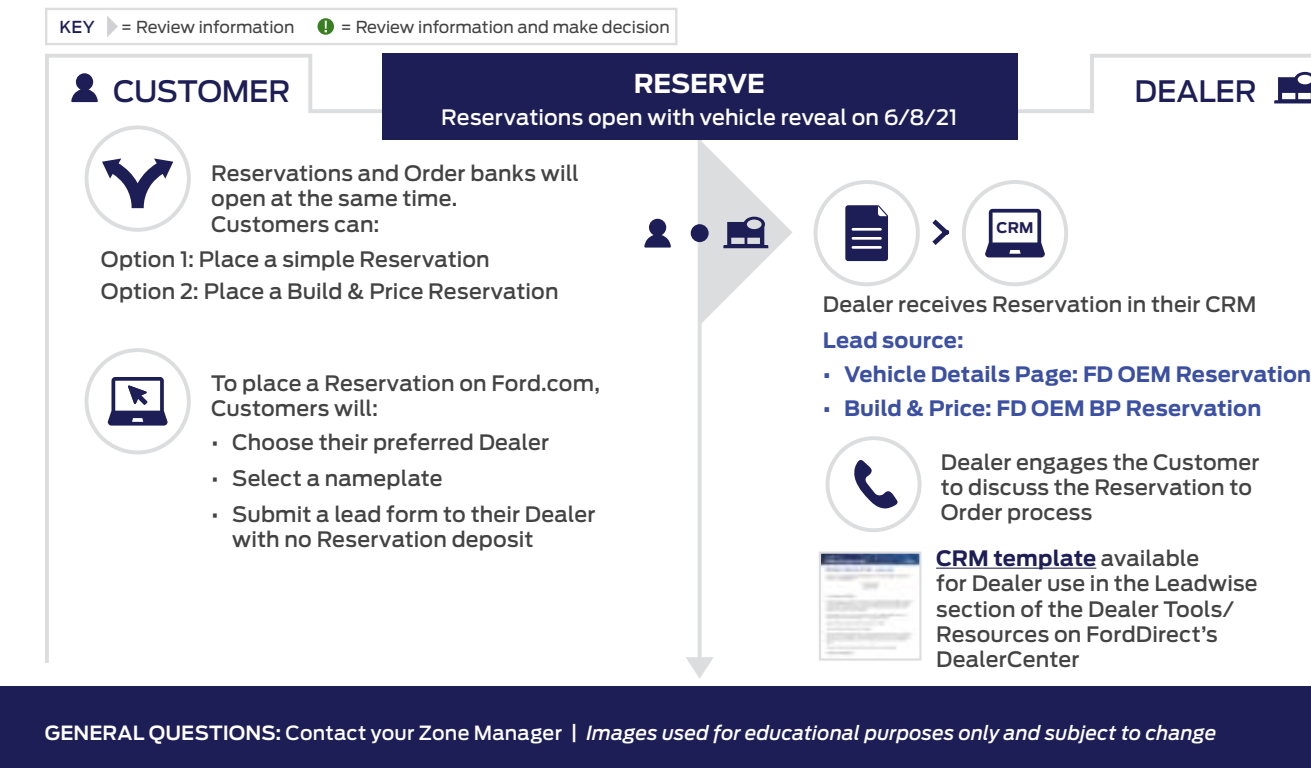

FOR MORE ON RESERVATIONS + ORDERING

Download the Maverick Reservation Job Aid available at FMCdealer.com.

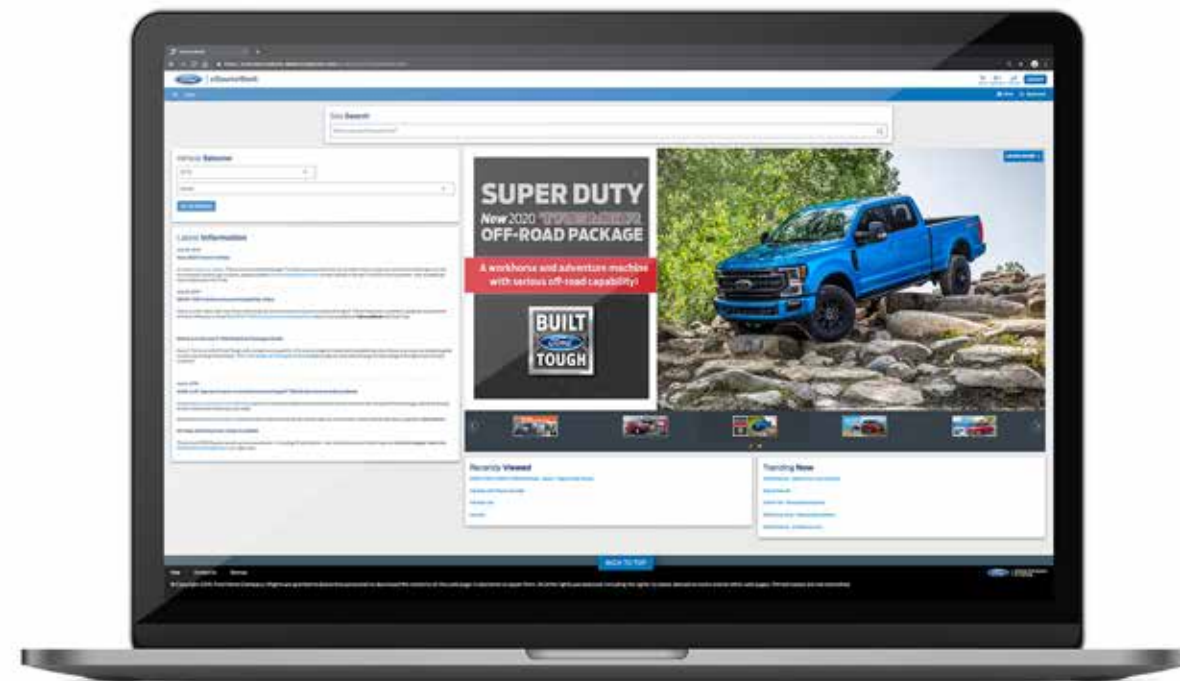

Ford eSourceBook

Your trusted, go-to resource for Ford Product and Technology information – add a link to your smartphone homepage today!

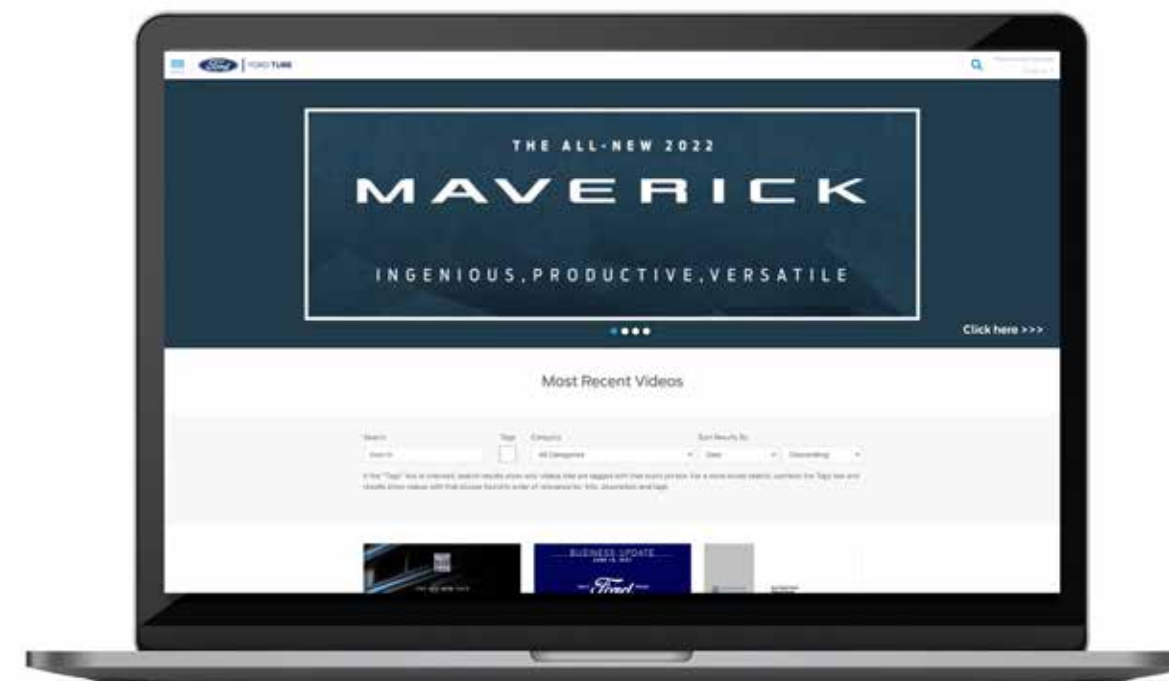

FordTube.dealerconnection.com

For even more in-depth information and visuals, be sure to watch Maverick videos, including archived launch video programs.

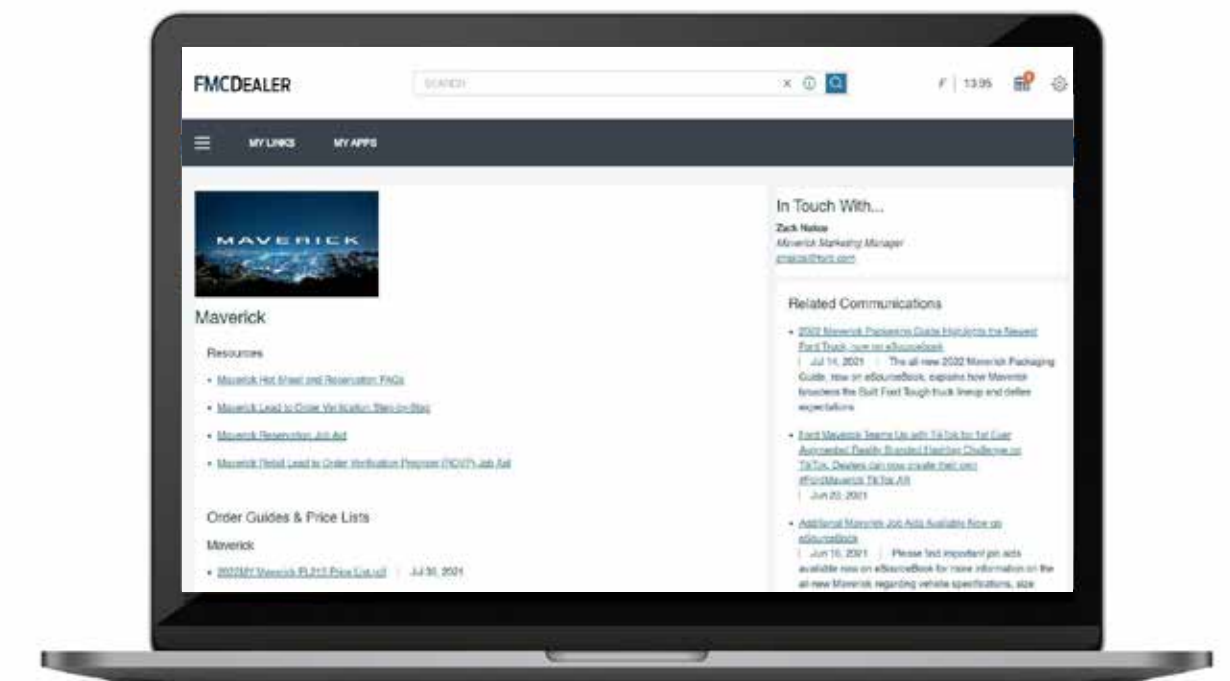

FMCdealer.com

Find the “Order Guides & Price Lists” section under the “Sales” tab.

STAY IN THE KNOW

Receive timely alerts when new product or technology information is available. Simply text FORD to 42992.¹

¹By opting in, you agree to receive autodialed text messages from Ford Retailer Education & Training (RE&T) to the number provided, and you confirm that you are the subscriber associated with the mobile phone number. Frequency may vary. Message and data rates may apply. For Product and Technology Training, Text HELP to 42992. Text STOP to 42992 to opt out. Privacy: Your mobile number will only be used to fulfill your request to receive certain RE&T text messages.

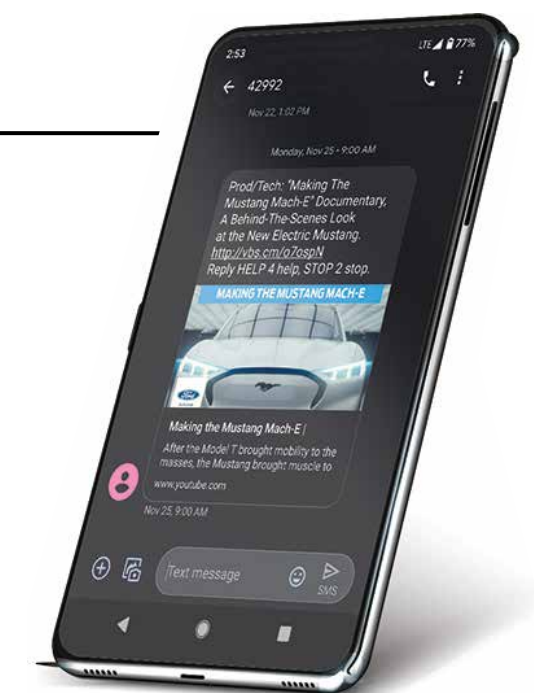



**Retailer Education
& Training**

© July 2021 by Ford Motor Company. Not intended for advertising purposes. Intended for use by dealership personnel to inform consumers. For Certified Ford Dealership personnel use only. All Ford product illustrations and specifications mentioned in this publication are based on the latest product information at the time of publication approval. Competitive information mentioned is based on generally available industry data. Ford reserves the right to change specifications, equipment, designs or prices without prior notice and without incurring obligation.

